

LADDER PULL HANDLES

SQUARE PULL HANDLE BACK-TO-BACK -
SATIN STAINLESS STEEL

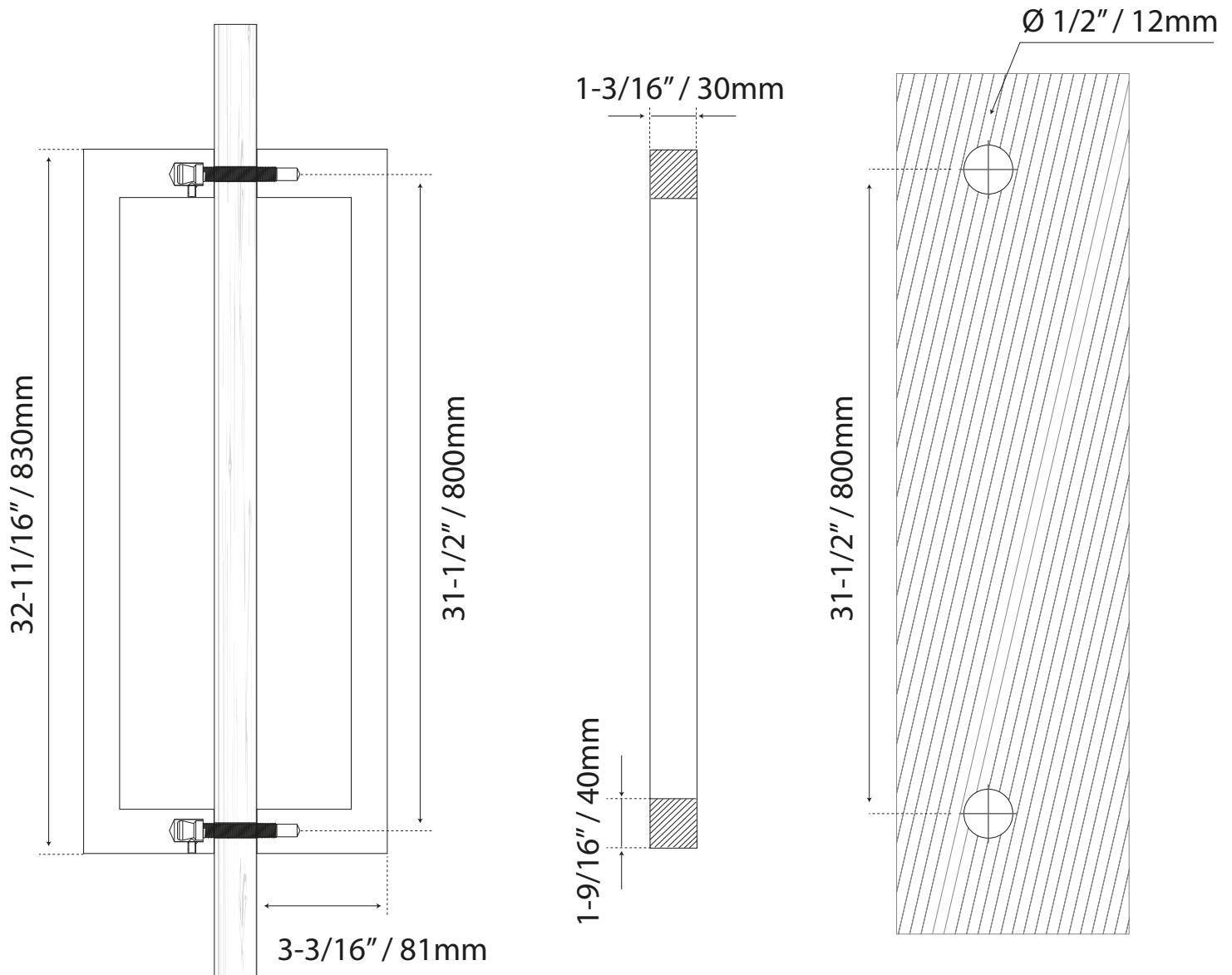

COD. CHCP004-800
Cutting guide



unscaled format