

# LADDER PULL HANDLES

## SQUARE PULL HANDLE BACK-TO-BACK - STAINLESS STEEL



COD. CHCP011-800

Cutting guide

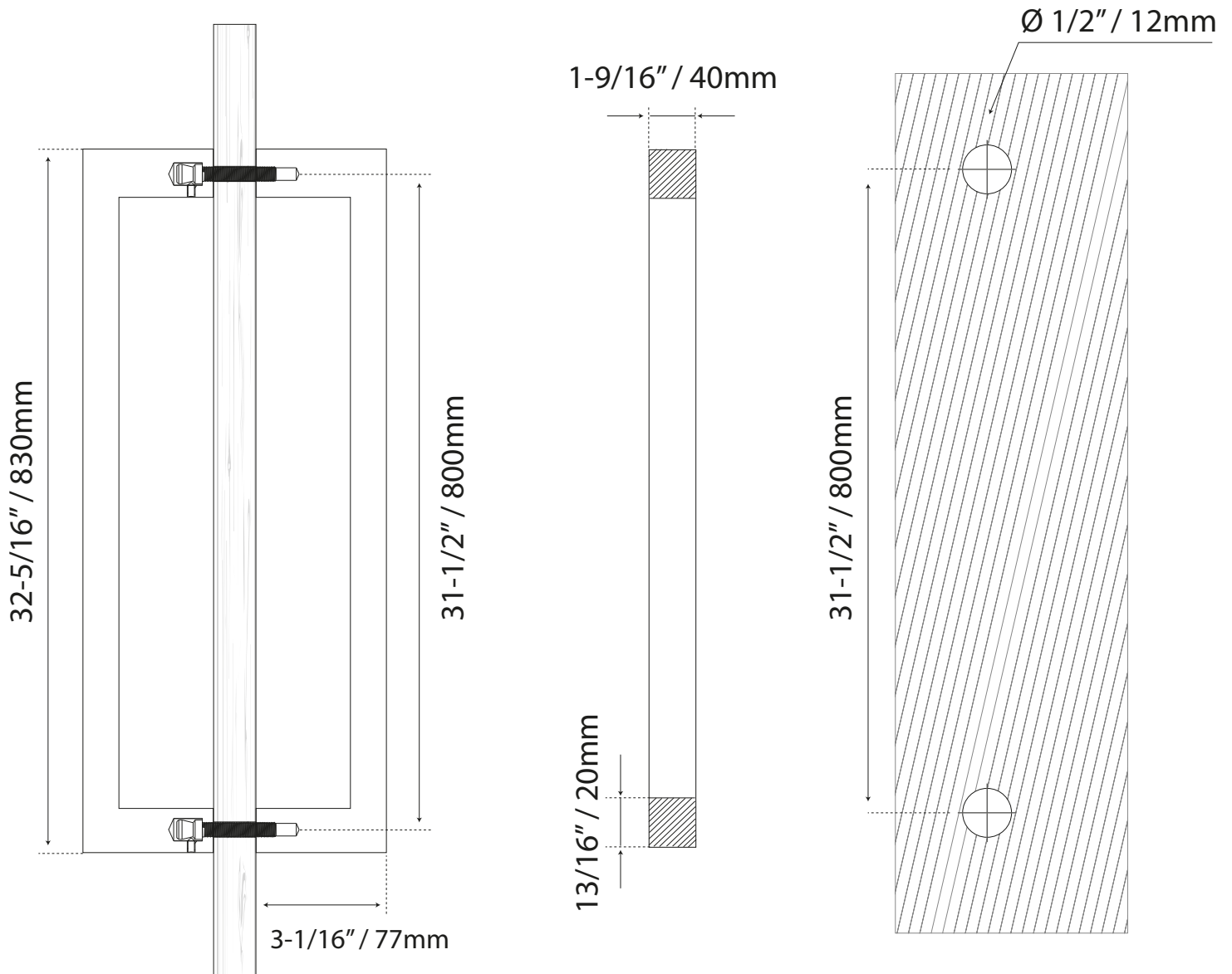

unscaled format